

120mΩ, 1.8A Power Switch with Adjustable Current Limit

General Description

The RT9728B is a cost effective, low voltage, single P-MOSFET power switch IC for USB application with a adjustable current limit feature. Low switch-on resistance (typ. 120mΩ) and low supply current (typ. 120μA) are realized in this IC. The RT9728B can offer a adjustable current limit threshold between 75mA and 1.8A (typ.) via an external resistor. The ±10% current limit accuracy can be realized for all current limit settings. In addition, a flag output is available to indicate fault conditions to the local USB controller. Furthermore, the chip also integrates an embedded delay function to prevent mis-operation due to high inrush current. The RT9728B is an ideal solution for USB power supplies and can support flexible applications since it is suitable for various current limit requirements. It is available in the SOT-23-6 and WDFN-6L 2x2 packages.

Applications

- USB Bus/Self Powered Hubs
- USB Peripheral Ports
- ACPI Power Distribution
- Battery Power Equipment
- 3G/3.5G Data Card, Set-Top Boxes

Features

- ±10% Current Limit Accuracy @ 1.3A
- Adjustable Current Limit : 75mA to 1.8A (typ.)
- Meets USB Current Limiting Requirements
- Operating Voltage Range : 2.5V to 5.5V
- Reverse Input–Output Voltage Protection
- Built-in Soft-Start
- 120mΩ P-MOSFET
- 120μA Supply Current
- RoHS Compliant and Halogen Free

Ordering Information

RT9728B	□	□	□
	└─	└─	└─
	Package Type		
	E : SOT-23-6		
	QW : WDFN-6L 2x2		
	└─	└─	└─
	Lead Plating System		
	G : Green (Halogen Free and Pb Free)		
	└─	└─	└─
	H : Chip Enable High		
	L : Chip Enable Low		

Note :

Richtek products are :

- ▶ RoHS compliant and compatible with the current requirements of IPC/JEDEC J-STD-020.
- ▶ Suitable for use in SnPb or Pb-free soldering processes.

Simplified Application Circuit

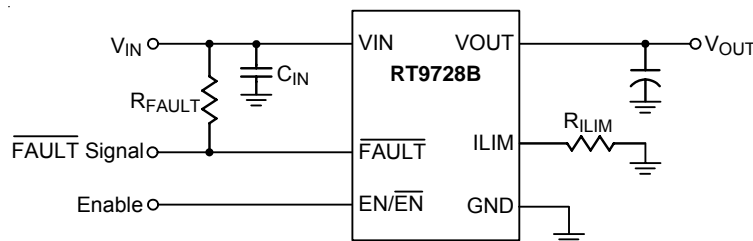

Marking Information

RT9728BHGE

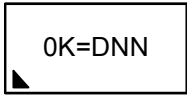

0K= : Product Code
DNN : Date Code

RT9728BLGE

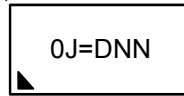

0J= : Product Code
DNN : Date Code

RT9728BHGQW

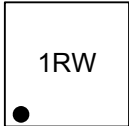

1R : Product Code
W : Date Code

RT9728BLGQW

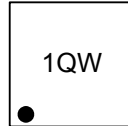

1Q : Product Code
W : Date Code

Pin Configurations

(TOP VIEW)

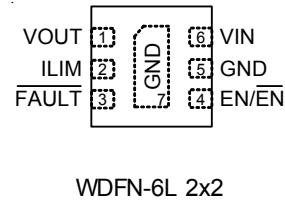
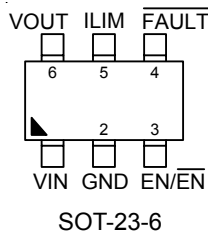

Functional Pin Description

Pin No.		Pin Name	Pin Function
SOT-23-6	WDFN-6L 2x2		
1	6	VIN	Power Input.
2	5, 7 (Exposed Pad)	GND	Ground. The exposed pad must be soldered to a large PCB and connected to GND for maximum power dissipation.
3	4	EN/ $\overline{\text{EN}}$	Enable Control Input.
4	3	$\overline{\text{FAULT}}$	Active-Low Open-Drain Output. Asserted during over-current, over-temperature, or reverse-voltage conditions.
5	2	ILIM	Current Limit Setting. Connect an external resistor to set current limit threshold. $15\text{k}\Omega \leq R_{\text{ILIM}} \leq 232\text{k}\Omega$ is recommended.
6	1	VOUT	Power Switch Output.

Function Block Diagram

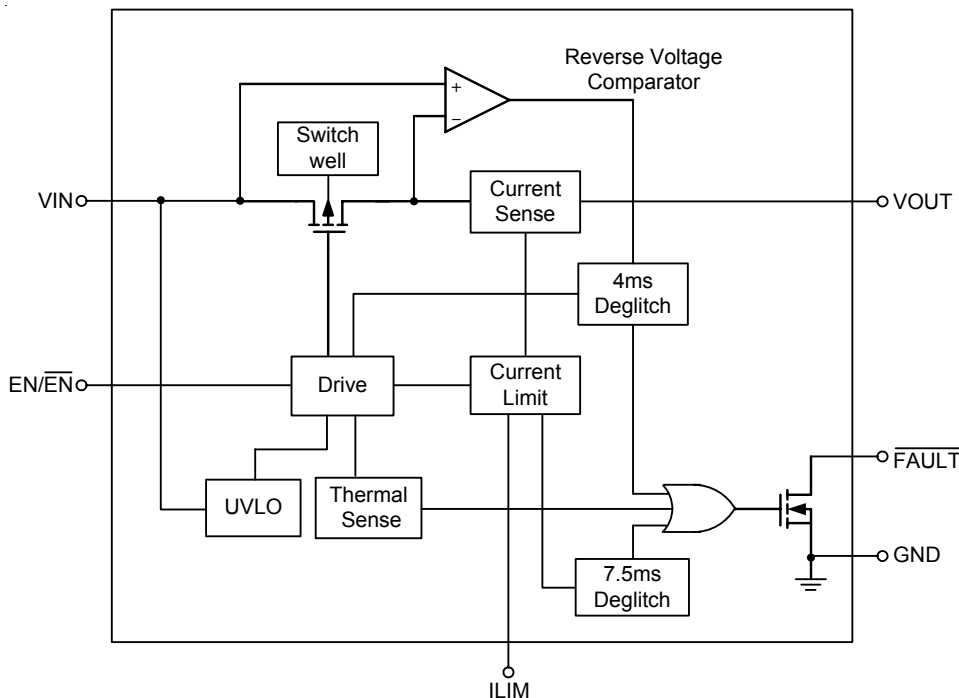

Operation

The RT9728B is a current-limited power switch using P-MOSFET for applications where short-circuit or heavy capacitive loads will be encountered. These devices allow users to adjust the current limit threshold between 75mA and 1.8A (typ.) via an external resistor. Additional device shutdown features include over-temperature protection and reverse-voltage protection.

The RT9728B provides built-in soft-start function. The driver controls the gate voltage of the power switch. The driver incorporates circuitry that controls the rising time and falling time of the output voltage to limit large inrush current and voltage surges. The RT9728B enters constant-current mode when the load exceeds the current limit threshold.

Absolute Maximum Ratings (Note 1)

- Supply Input Voltage, V_{IN} ----- -0.3V to 6V
- Other Pins ----- -0.3V to 6V
- Power Dissipation, P_D @ $T_A = 25^\circ\text{C}$
 - SOT-23-6 ----- 0.4W
 - WDFN-6L 2x2 ----- 0.606W
- Package Thermal Resistance (Note 2)
 - SOT-23-6, θ_{JA} ----- 250°C/W
 - WDFN-6L 2x2, θ_{JA} ----- 165°C/W
 - WDFN-6L 2x2, θ_{JC} ----- 7°C/W
- Lead Temperature (Soldering, 10 sec.) ----- 260°C
- Junction Temperature ----- 150°C
- Storage Temperature Range ----- -65°C to 150°C
- ESD Susceptibility (Note 3)
 - HBM (Human Body Model) ----- 2kV

Recommended Operating Conditions (Note 4)

- Supply Input Voltage, V_{IN} ----- 2.5V to 5.5V
- Junction Temperature Range ----- -40°C to 125°C
- Ambient Temperature Range ----- -40°C to 85°C

Electrical Characteristics

($V_{IN} = 3.6\text{V}$, $15\text{k}\Omega \leq R_{ILIM} \leq 232\text{k}\Omega$, $T_A = 25^\circ\text{C}$, unless otherwise specified)

Parameter	Symbol	Test Conditions	Min	Typ	Max	Unit	
EN Input Voltage	Logic-High	V_{IH}	1.1	--	--	V	
	Logic-Low	V_{IL}	--	--	0.66		
Current Limit Threshold Resistor Range	R_{ILIM}	(nominal 1%) from I_{LIM} to GND	15	--	232	k Ω	
Under-Voltage Lockout Threshold	V_{UVLO}	V_{IN} Rising	--	2.3	--	V	
		V_{IN} Falling	--	2.1	--		
Shutdown Current	I_{SHDN}	$V_{IN} = 3.6\text{V}$, No Load on V_{OUT} , $V_{EN} = 0\text{V}$	--	1	3	μA	
Quiescent Current	I_Q	$V_{IN} = 5.5\text{V}$, No Load on V_{OUT}	$R_{ILIM} = 20\text{k}\Omega$	--	120	170	μA
			$R_{ILIM} = 210\text{k}\Omega$	--	120	170	
Reverse Leakage Current	I_{REV}	$V_{OUT} = 5\text{V}$, $V_{IN} = 0\text{V}$	--	1	10	μA	
Thermal Shutdown Threshold	T_{SD}		--	160	--	$^\circ\text{C}$	
Static Drain-Source On-State Resistance	$R_{DS(ON)}$	$I_{SW} = 0.2\text{A}$	--	120	--	m Ω	
Current Limit	I_{LIM}	$R_{ILIM} = 20\text{k}\Omega$	1166	1295	1425	mA	
		$R_{ILIM} = 49.9\text{k}\Omega$	468	520	572		
		$R_{ILIM} = 210\text{k}\Omega$	104	130	156		
		I_{LIM} Shorted to V_{IN}	--	75	--		

Parameter	Symbol	Test Conditions	Min	Typ	Max	Unit
Reverse Voltage Comparator Trip Point ($V_{OUT} - V_{IN}$)			--	135	--	mV
\overline{FAULT} Output Low Voltage	V_{OL}	$I_{\overline{FAULT}} = 1\text{mA}$	--	180	--	mV
\overline{FAULT} Off State Leakage		$V_{\overline{FAULT}} = 5.5\text{V}$	--	1	--	μA
\overline{FAULT} Deglitch		\overline{FAULT} assertion or de-assertion due to over-current condition	5	7.5	10	ms
		\overline{FAULT} assertion or de-assertion due to reverse-voltage condition	2	4	6	

Note 1. Stresses beyond those listed “Absolute Maximum Ratings” may cause permanent damage to the device. These are stress ratings only, and functional operation of the device at these or any other conditions beyond those indicated in the operational sections of the specifications is not implied. Exposure to absolute maximum rating conditions may affect device reliability.

Note 2. θ_{JA} is measured at $T_A = 25^\circ\text{C}$ on a low effective thermal conductivity single-layer test board per JEDEC 51-3. θ_{JC} is measured at the exposed pad of the package.

Note 3. Devices are ESD sensitive. Handling precaution is recommended.

Note 4. The device is not guaranteed to function outside its operating conditions.

Typical Application Circuit

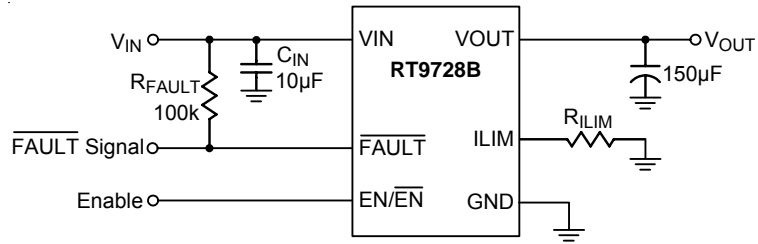

Typical Operating Characteristics

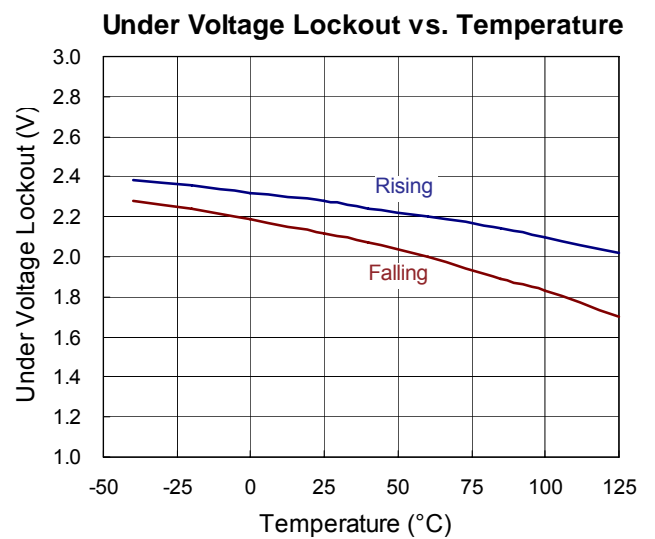
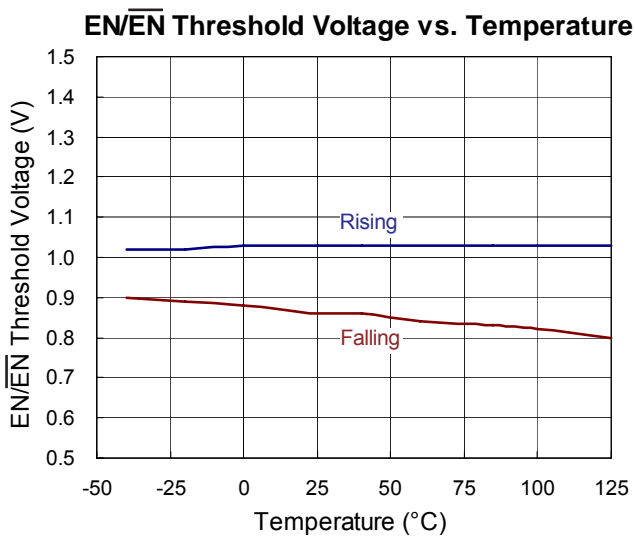
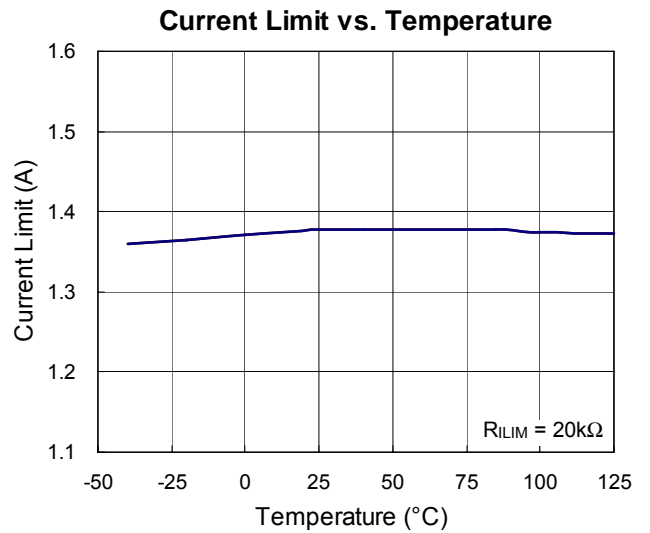
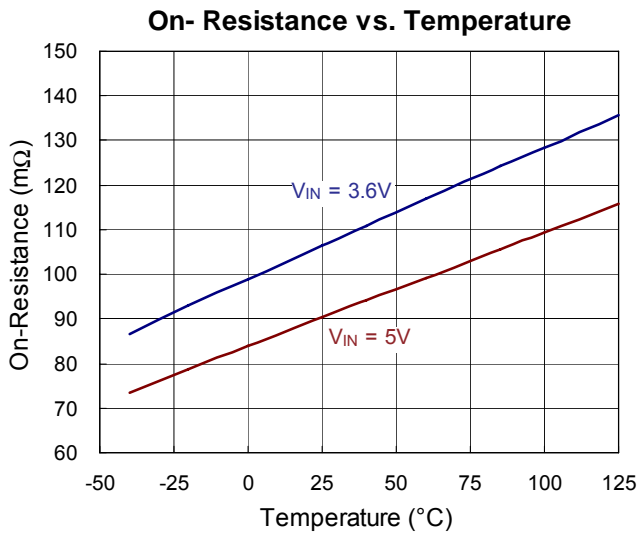
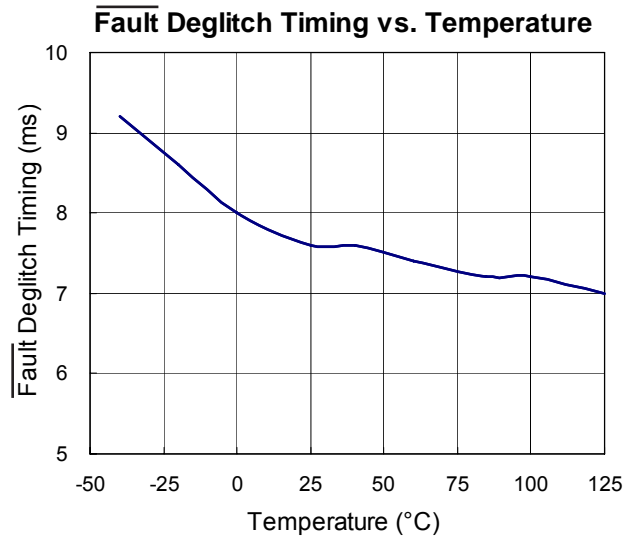
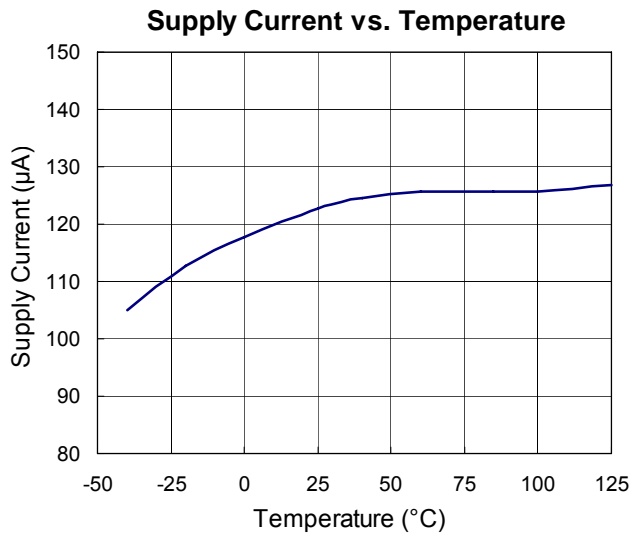

Power On from EN

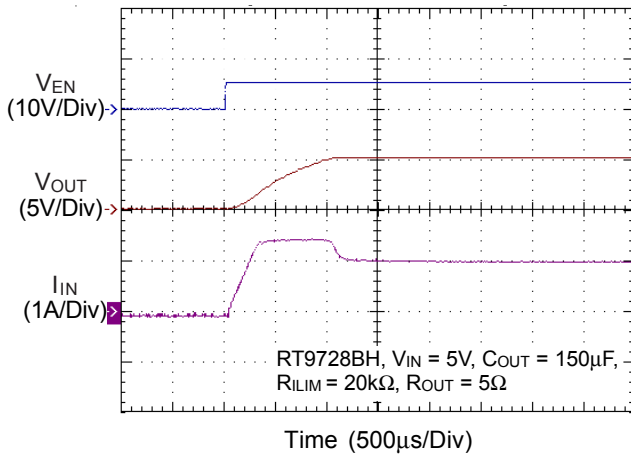

Power Off from EN

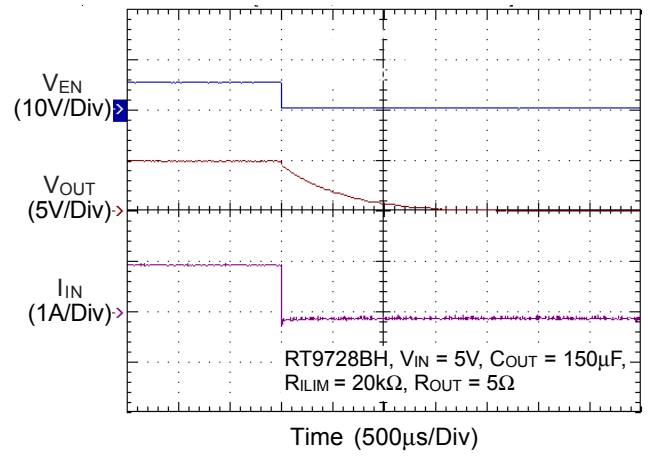

Power On from \overline{EN}

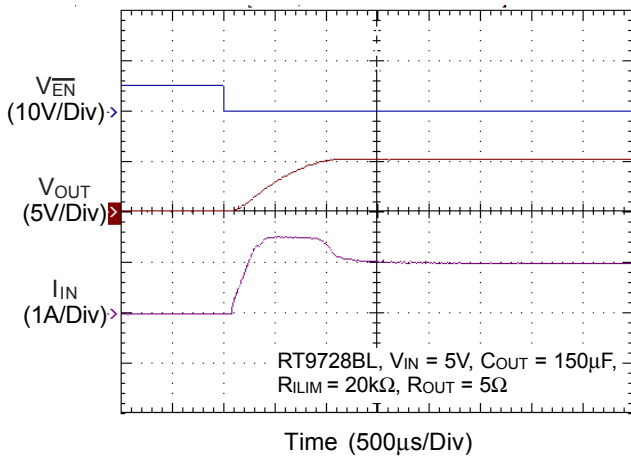

Power Off from \overline{EN}

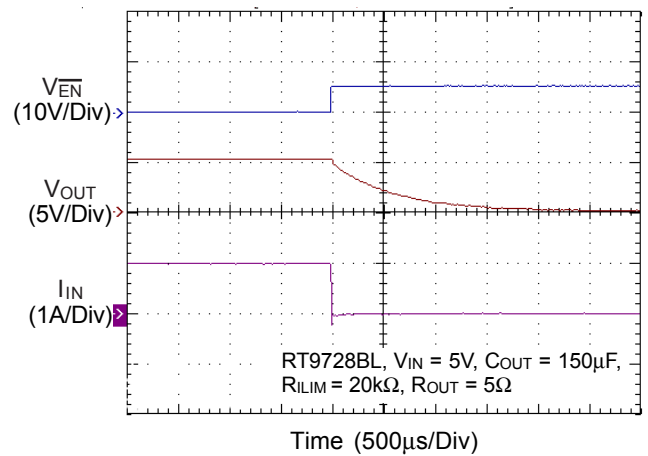

Current Limit

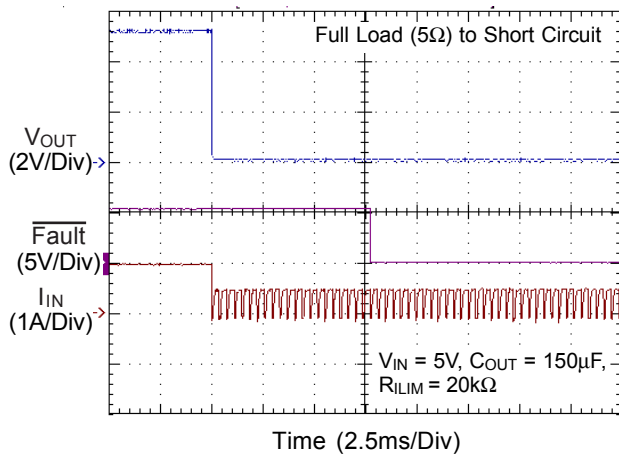

Current Limit

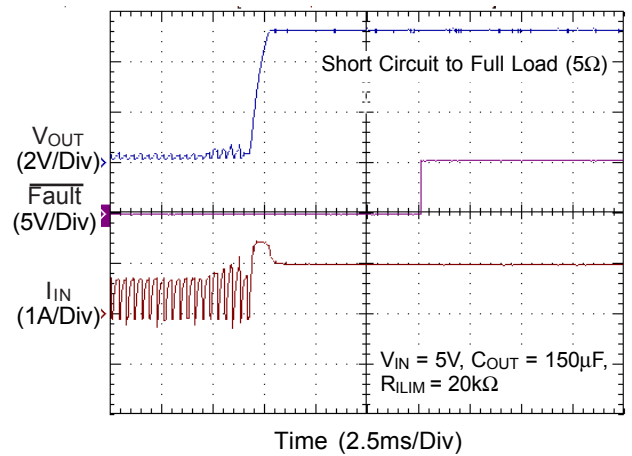

Current Limit

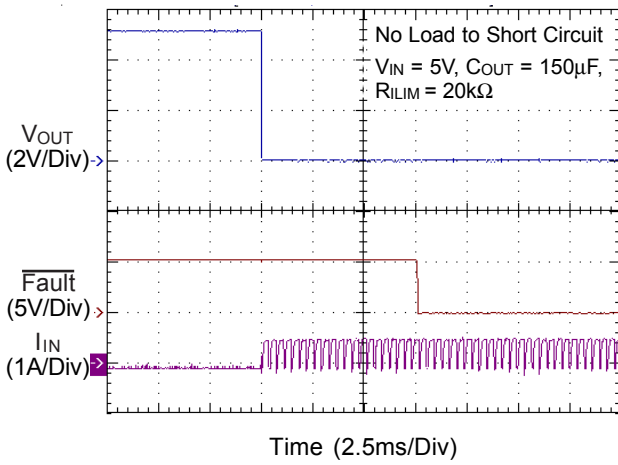

Current Limit

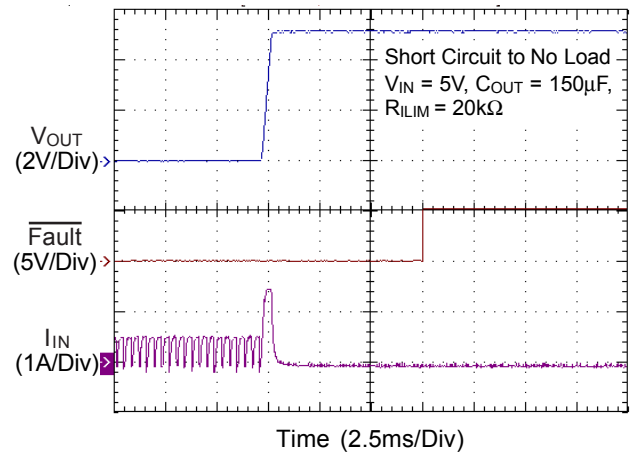

Static Drain-Source Current vs. $V_{IN} - V_{OUT}$

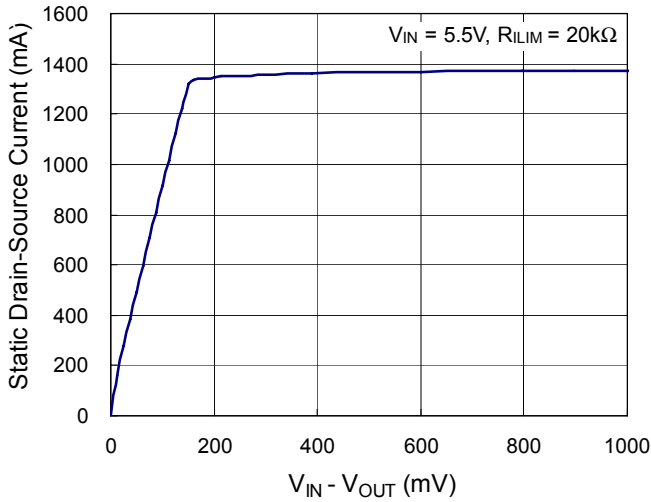

Static Drain-Source Current vs. $V_{IN} - V_{OUT}$

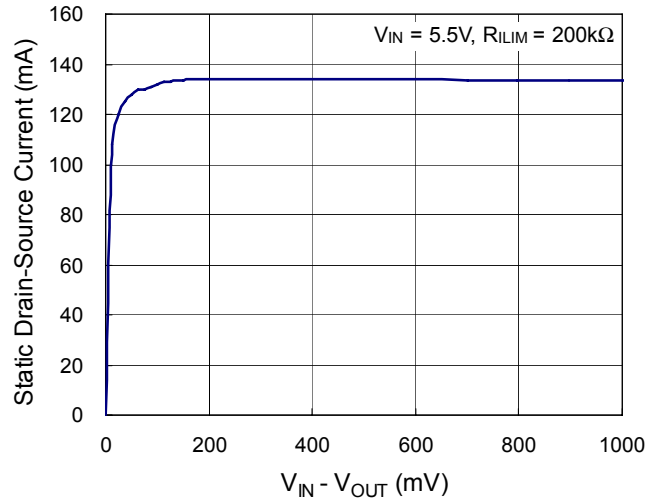

Applications Information

The RT9728B is a single P-MOSFET power switch with an active-high/low enable input, optimized for self-powered and bus-powered Universal Serial Bus (USB) applications. The switch's low $R_{DS(ON)}$ meets USB voltage drop requirements and a flag output is available to indicate fault conditions to the local USB controller.

Current Limit and Short-Circuit Protection

When a heavy load or short-circuit situation occurs while the switch is enabled, a large transient current may flow through the device. The RT9728B includes current-limit circuitry to prevent the MOSFET switch and the hub downstream ports from damage due to large transient current. The RT9728B provides an adjustable current limit threshold between 120mA and 1.8A (typ) via an external resistor, R_{ILIM} , whose resistance is between 15k Ω and 232k Ω . However, if the ILIM pin is connected to V_{IN} , the current limit threshold will be 75mA (typ). Once the current

limit threshold is exceeded, the device enters constant-current mode until either thermal shutdown occurs or the fault is removed. Figure 1 shows the curve of current limit value vs. R_{ILIM} resistor. The recommended R_{ILIM} resistor selection is shown in Table 1.

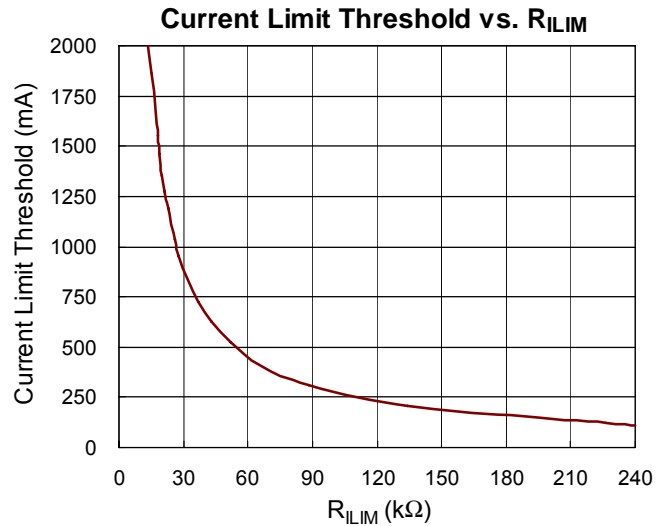

Figure 1. Current Limit Threshold vs. R_{ILIM}

Table 1. Recommended R_{ILIM} Resistor Selection

Desired Nominal Current Limit (mA)	Ideal Resistor (k Ω)	Closest 1% Resistor (k Ω)	Actual Limits (Include R Tolerance)		
			IOS Min (mA)	IOS Nom (mA)	IOS Max (mA)
75	Short ILIM to VIN		50.0	75.0	100.0
120	226.1	226.0	101.3	120.0	142.1
200	134.0	133.0	173.7	201.5	233.9
300	88.5	88.7	262.1	299.4	342.3
400	65.9	66.5	351.1	396.7	448.7
500	52.5	52.3	443.9	501.6	562.4
600	43.5	43.2	535.1	604.6	674.1
700	37.2	37.4	616.0	696.0	776.0
800	32.4	32.4	708.7	800.8	892.9
900	28.7	28.7	797.8	901.5	1005.2
1000	25.8	26.1	875.4	989.1	1102.8
1100	23.4	23.2	982.1	1109.7	1237.3
1200	21.4	21.5	1057.9	1195.4	1332.9
1300	19.7	19.6	1158.0	1308.5	1459.0
1400	18.5	18.7	1225.7	1385.0	1544.3
1500	17.3	17.4	1317.3	1488.5	1659.7
1600	16.2	16.2	1414.8	1598.7	1782.6
1700	15.2	15.0	1528.1	1726.7	1925.3
1800	14.4	14.3	1602.9	1811.2	2019.5

Fault Flag

The RT9728B provides a $\overline{\text{FAULT}}$ signal pin which is an open-drain N-MOSFET output. This open-drain output is pulled low when current exceeds current limit threshold. The $\overline{\text{FAULT}}$ output is capable of sinking a 1mA load to 180mV (typ.) above ground. The $\overline{\text{FAULT}}$ pin requires a pull-up resistor; this resistor should be large in value to reduce energy drain. A 100kΩ pull-up resistor works well for most applications. In case of an over-current condition, $\overline{\text{FAULT}}$ will be asserted only after the flag response delay time, t_D , has elapsed. This ensures that $\overline{\text{FAULT}}$ is asserted upon valid over-current conditions and that erroneous error reporting is eliminated. For example, false over-current conditions may occur during hot-plug events when extremely large capacitive loads are connected, which induces a high transient inrush current that exceeds the current limit threshold. The $\overline{\text{FAULT}}$ response delay time, t_D , is typically 7.5ms.

Supply Filter/Bypass Capacitor

A 10μF low ESR ceramic capacitor connected from V_{IN} to GND and located close to the device is strongly recommended to prevent input voltage drooping during hot-plug events. However, higher capacitor values may be used to further reduce the voltage droop on the input. Without this bypass capacitor, an output short may cause sufficient ringing on the input (from source lead inductance) to destroy the internal control circuitry. Note that the input transient voltage must never exceed 6V as stated in the Absolute Maximum Ratings.

Output Filter Capacitor

A low ESR 150μF aluminum electrolytic capacitor connected between V_{OUT} and GND is strongly recommended to meet the USB standard maximum droop requirement for the hub, VBUS. Standard bypass methods should be used to minimize inductance and resistance between the bypass capacitor and the downstream connector to reduce EMI and decouple voltage droop caused by hot-insertion transients in downstream cables. Ferrite beads in series with VBUS, the ground line and the 0.1μF bypass capacitors at the power connector pins

are recommended for EMI and ESD protection. The bypass capacitor itself should have a low dissipation factor to allow decoupling at higher frequencies.

Chip Enable Input

The RT9728BH/L is disabled when the $\overline{\text{EN/EN}}$ pin is in a logic-low/high condition. During this condition, the internal circuitry and MOSFET are turned off, reducing the supply current to 1μA typically. The maximum guaranteed voltage for a logic-low at the $\overline{\text{EN/EN}}$ pin is 0.66V. A minimum guaranteed voltage of 1.1V at the $\overline{\text{EN/EN}}$ pin will turn off the RT9728B. Floating the input may cause unpredictable operation. $\overline{\text{EN/EN}}$ should not be allowed to go negative with respect to GND.

Under-Voltage Lockout

Under-Voltage Lockout (UVLO) prevents the MOSFET switch from turning on until input voltage exceeds approximately 2.3V. If input voltage drops below approximately 2.1V, UVLO turns off the MOSFET switch and $\overline{\text{FAULT}}$ will be asserted accordingly. The under-voltage lockout detection functions only when the switch is enabled.

Thermal Considerations

For continuous operation, do not exceed absolute maximum junction temperature. The maximum power dissipation depends on the thermal resistance of the IC package, PCB layout, rate of surrounding airflow, and difference between junction and ambient temperature. The maximum power dissipation can be calculated by the following formula :

$$P_{D(MAX)} = (T_{J(MAX)} - T_A) / \theta_{JA}$$

where $T_{J(MAX)}$ is the maximum junction temperature, T_A is the ambient temperature, and θ_{JA} is the junction to ambient thermal resistance.

For recommended operating condition specifications, the maximum junction temperature is 125°C. The junction to ambient thermal resistance, θ_{JA} , is layout dependent. For SOT-23-6 packages, the thermal resistance, θ_{JA} , is 250°C/W on a standard JEDEC 51-3 single-layer thermal test

board. For WDFN-6L 2x2 packages, the thermal resistance, θ_{JA} , is $165^{\circ}\text{C}/\text{W}$ on a standard JEDEC 51-3 single-layer thermal test board. The maximum power dissipation at $T_A = 25^{\circ}\text{C}$ can be calculated by the following formula :

$$P_{D(\text{MAX})} = (125^{\circ}\text{C} - 25^{\circ}\text{C}) / (250^{\circ}\text{C}/\text{W}) = 0.400\text{W for SOT-23-6 package}$$

$$P_{D(\text{MAX})} = (125^{\circ}\text{C} - 25^{\circ}\text{C}) / (165^{\circ}\text{C}/\text{W}) = 0.606\text{W for WDFN-6L 2x2 package}$$

The maximum power dissipation depends on the operating ambient temperature for fixed $T_{J(\text{MAX})}$ and thermal resistance, θ_{JA} . The derating curves in Figure 2 allow the designer to see the effect of rising ambient temperature on the maximum power dissipation.

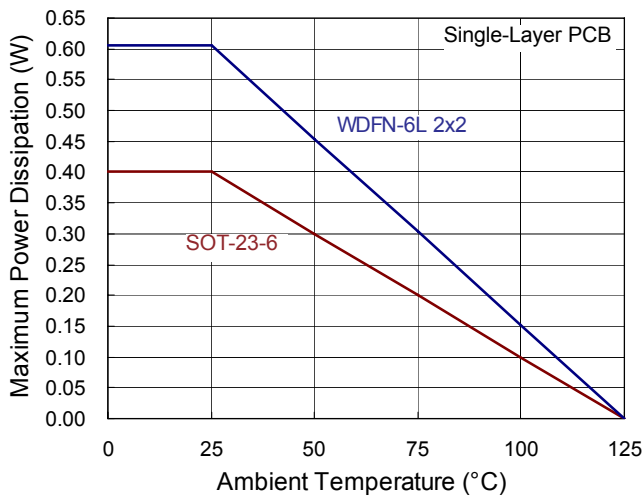
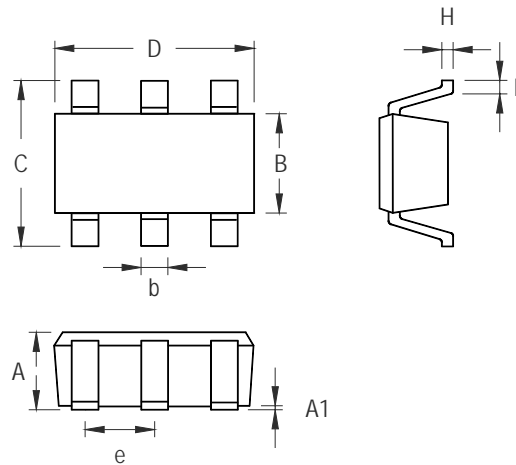

Figure 2. Derating Curve of Maximum Power Dissipation

Outline Dimension



Symbol	Dimensions In Millimeters		Dimensions In Inches	
	Min	Max	Min	Max
A	0.889	1.295	0.031	0.051
A1	0.000	0.152	0.000	0.006
B	1.397	1.803	0.055	0.071
b	0.250	0.560	0.010	0.022
C	2.591	2.997	0.102	0.118
D	2.692	3.099	0.106	0.122
e	0.838	1.041	0.033	0.041
H	0.080	0.254	0.003	0.010
L	0.300	0.610	0.012	0.024

SOT-23-6 Surface Mount Package

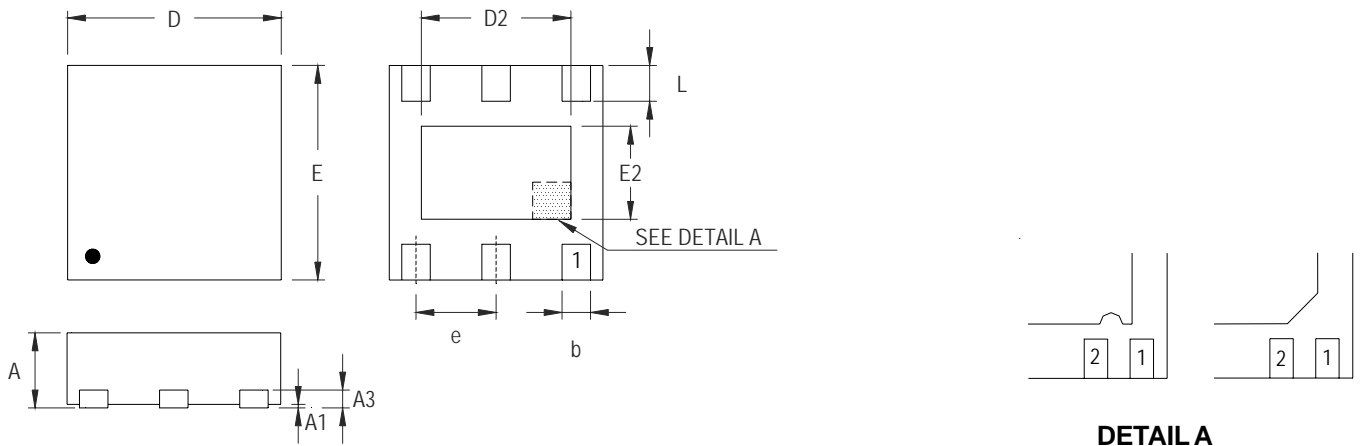

DETAIL A

Pin #1 ID and Tie Bar Mark Options

Note : The configuration of the Pin #1 identifier is optional, but must be located within the zone indicated.

Symbol	Dimensions In Millimeters		Dimensions In Inches	
	Min	Max	Min	Max
A	0.700	0.800	0.028	0.031
A1	0.000	0.050	0.000	0.002
A3	0.175	0.250	0.007	0.010
b	0.200	0.350	0.008	0.014
D	1.950	2.050	0.077	0.081
D2	1.000	1.450	0.039	0.057
E	1.950	2.050	0.077	0.081
E2	0.500	0.850	0.020	0.033
e	0.650		0.026	
L	0.300	0.400	0.012	0.016

W-Type 6L DFN 2x2 Package

Richtek Technology Corporation

5F, No. 20, Taiyuen Street, Chupei City
 Hsinchu, Taiwan, R.O.C.
 Tel: (8863)5526789

Richtek products are sold by description only. Richtek reserves the right to change the circuitry and/or specifications without notice at any time. Customers should obtain the latest relevant information and data sheets before placing orders and should verify that such information is current and complete. Richtek cannot assume responsibility for use of any circuitry other than circuitry entirely embodied in a Richtek product. Information furnished by Richtek is believed to be accurate and reliable. However, no responsibility is assumed by Richtek or its subsidiaries for its use; nor for any infringements of patents or other rights of third parties which may result from its use. No license is granted by implication or otherwise under any patent or patent rights of Richtek or its subsidiaries.